

Article number: 205345450M10D

Description: E+G Three-star knobs - GN 5345.4-50-M10-D

## Measures

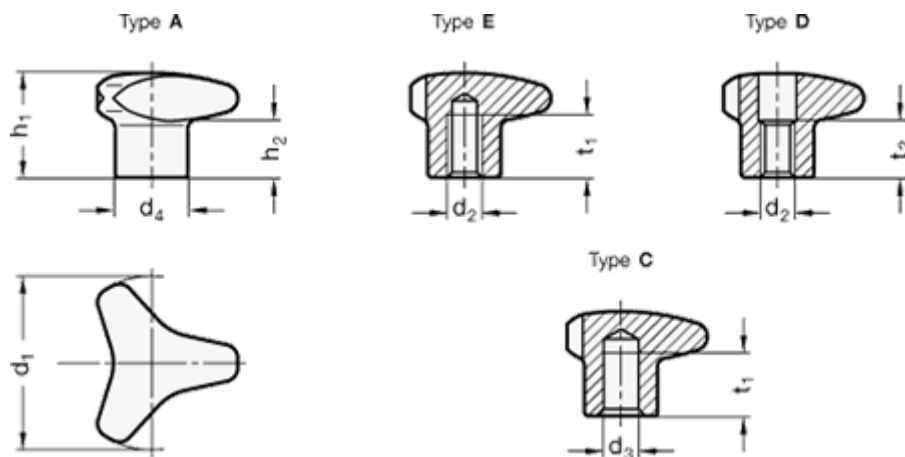

d1	= 50
d2	= M10
d3 H7	= -
d4	= -
h1	= 30
h2	= 17
t1 min.	= -
t2	= 16

Weight (g) = 140